



YouTube



Facebook



LinkedIn

MK6 PRO

In pursuit 100% complete satisfaction

88-668T

SINCE

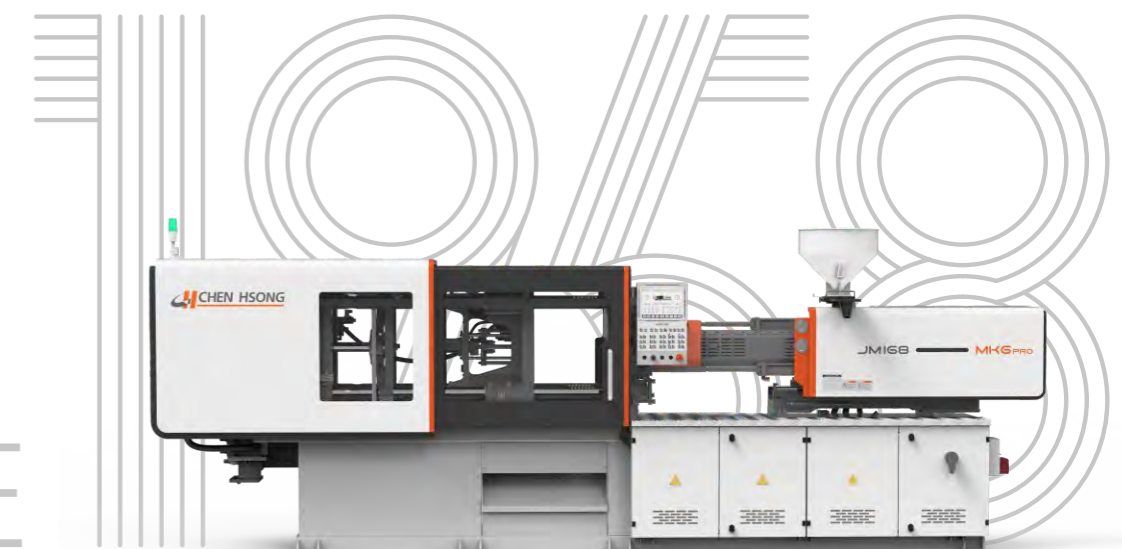

CHEN HSONG

Powering Your Future in Intelligent Injection Molding

Driven by its founding principle, "Your Vision is Our Mission", the Chen Hsong Group, established in 1958 and publicly listed in Hong Kong since 1991, has evolved over nearly 70 years from an injection molding machine manufacturer into a one-stop total solutions provider in plastics manufacturing. As one of the world's largest producers of injection molding machines, Chen Hsong achieves unmatched quality through complete in-house manufacturing. This vertically integrated approach means controlling everything from ductile iron castings, parts fabrication and core components (such as advanced controllers) to final assembly. With a comprehensive product matrix serving diverse industries like automotive and medical, we are also spearheading smart manufacturing upgrades through the iChen™ Smart Family Suite, including the iChen™ Smart Factory MES, iChen™ Cloud platform, and iChen™ AI Molder, making the path to Industry 4.0 easily accessible for our global clientele.

800,000m²
R&D and Production Facilities (Four locations)

85+
Countries Globally

1,000,000+
Injection Molding Machines in the Field

120+
Global Technical & Service Centres



Headquarters in Hong Kong



Shenzhen Industrial Park Factory — 560000m²



Taiwan Taoyuan Factory — 30000m²



Foshan Shunde - Two Factories — 150000m²



Zhejiang Ningbo Factory — 70000m²



Shanwei Luhe Factory — 62360m²

Over 1 million+ Chen Hsong machines are in operation worldwide.

They all use Chen Hsong.



In pursuit of 100% complete satisfaction

The MK6 PRO is the new “professional” member of the world-renowned MK6 series, which was originally created by Chen Hsong and Japanese engineers through combining half a century of applications experience with top-of-the-line advanced technology and controls expertise. It seeks simply to be the best of its kind, in every aspect.

The MK6 PRO inherits its high reliability and non-compromising performance from the MK6 legacy, but also adds a brand-new, next-generation, high-end computing control platform, meticulously fine-tuned mechanics and hydraulics, and state-of-the-art control algorithms. It seeks to be even better, again, in every way.

Redefining professionalism, performance and value for the plastics industry

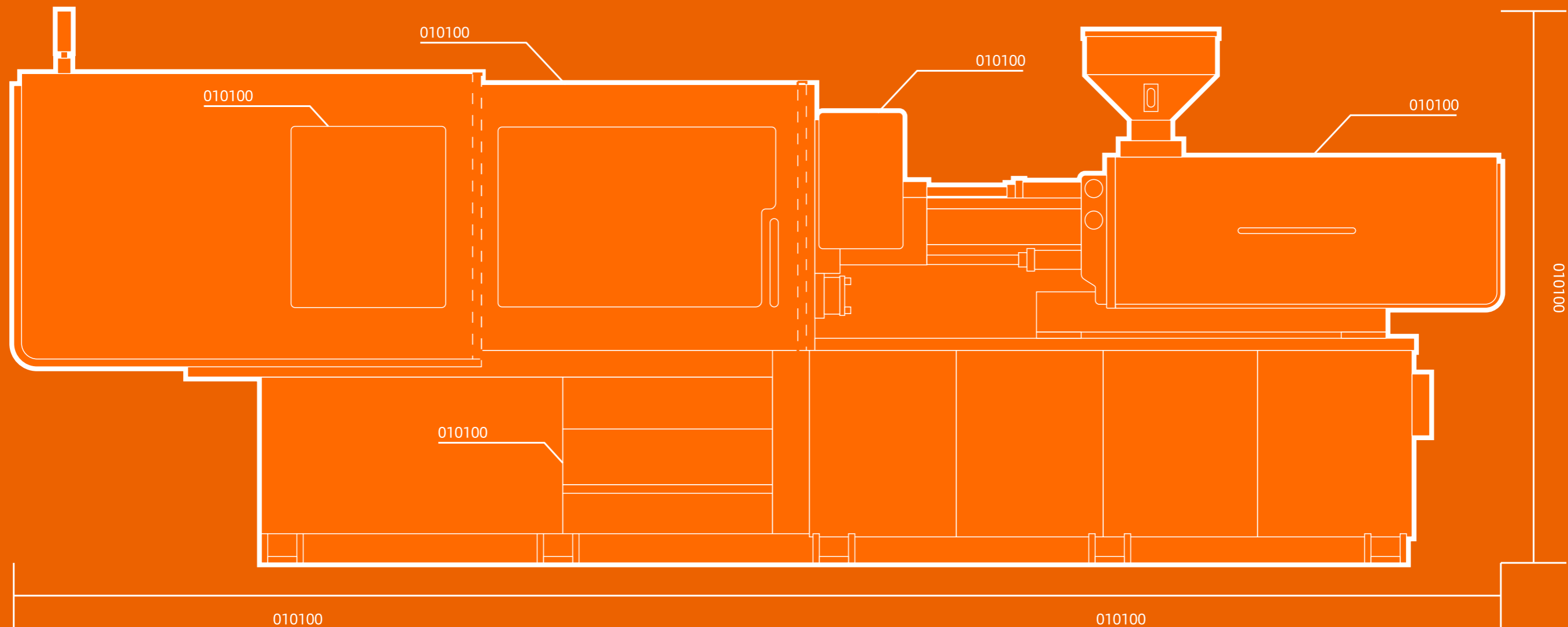

Redefining the professional injection moulding machine

01 Redefining ergonomics

02 Redefining precision controls

03 Redefining perfect quality

04 Redefining high performance

Redefining ergonomics

Beauty is both internal and external

-  Masterpiece of industrial design
Modern and pleasing
-  Professional ergonomics
User-friendly and easy to operate
-  Optimised structural design
High-strength construction with rock-solid stability
-  Glowing logo
Light up the future of the plastics processing



Lights up!

Redefining precision control

Next-gen intelligent computer controller

High-speed advanced CPU provides ample computing power for closed-loop calculations, leading to lightning-speed responses, ultra-high precision and exceptional stability.

- 01 12"/15" large-sized touch-screen LCD panel
- 02 Wicked-fast CPU for lightning responses
- 03 Ultimate user-friendly HMI
- 04 Intelligent controls and easy smart tuning
- 05 Over-drive performance
- 06 Comprehensive features set



The fastest compute platform

25%
higher HMI CPU
clock speed

60%
faster PLC CPU
clock speed and
I/O scan time



CPU clock speed	MK6 PRO	Competition
HMI	1.0GHz	0.8GHz
PLC	0.48GHz	0.3GHz

Advanced high-speed CPU enables lightning-fast closed-loop calculations for faster responses and higher precision.

Mainstream Linux-based O/S with modern GUI.

The best panel



- Touch-screen: Fast and precise
- Snappy and smooth
- Easy and simple
- One-touch access
- Physical buttons
- Slow operation
- Low resolution (800x600)

The largest features set

All the professional features you'd ever need for demanding applications.

- 01 USB interface
- 02 Ethernet interface
- 03 Intelligent Mold Open/Close Control
- 04 Closed-loop Injection/ejection control
- 05 Stored mould recipes
- 06 Production log
- 07 Upgrade system via USB
- 08 Automatic Saving of log Changes
- 09 Mold Recipe data Compatibility
- 10 Rapid-setting page
- 11 Comprehensive quality monitoring
- 12 Built-in digital oscilloscope to monitor any data point value
- 13 SPC data logs
- 14 One-touch access to pages
- 15 Free I/O Point Configuration
- 16 Screenshot at any time
- 17 Interface with auxiliaries
- 18 Freely programmable movements
- 19 MES interface
- 20 User Management

The highest over-drive

Increase injection speed by up to 20% for more flexible application scenarios.



The most intelligent

With Chen Hsong's proprietary advanced Japanese motion-control algorithms, running on a top-speed CPU, the highly-intelligent automatic clamping force adjustment mechanism achieves precision within $\pm 5\%$ of your set-point value without any human interaction.

There is no longer any need to rely on expensive high-precision transducers, experienced technicians or "black arts" for fine-tuned clamping adjustments. In the end, much fewer errors are made.

Shorter cycle time
and smoother clamp
motion.



MK6 PRO intelligent auto clamp adjustment
Dedicated page for one-touch operation
Simple and easy-to-use interface

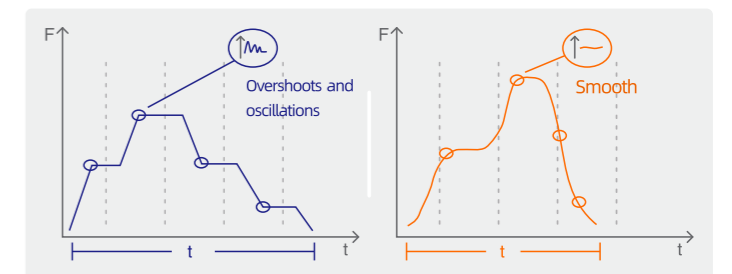

The most connected

Easy and effective Industry 4.0 smart manufacturing, now at your fingertips, with Chen Hsong's iChen Cloud online data platform.

True IOT connectivity, remote control and diagnostics, and fully networked productivity.

* iPad visualization interface



Redefining perfect quality

Advanced toggle design

Proprietary Japanese mechanical design with highly-optimised motion profile; core components toggle produced on high-end machining centres to 0.01mm precision.

Patented Circular Platen design

Proprietary Circular Platen design (patented) is a technological marvel perfected from years of detailed structural analysis, ensuring smooth stress distribution throughout the platen for maximum part quality and mould protection.

Professional screw designs

Leveraging over 60 years of application expertise and field experience, professional screw designs are available for an amazingly wide range of applications demands and resins. There is always an optimised screw ready for your particular, unique processing needs.

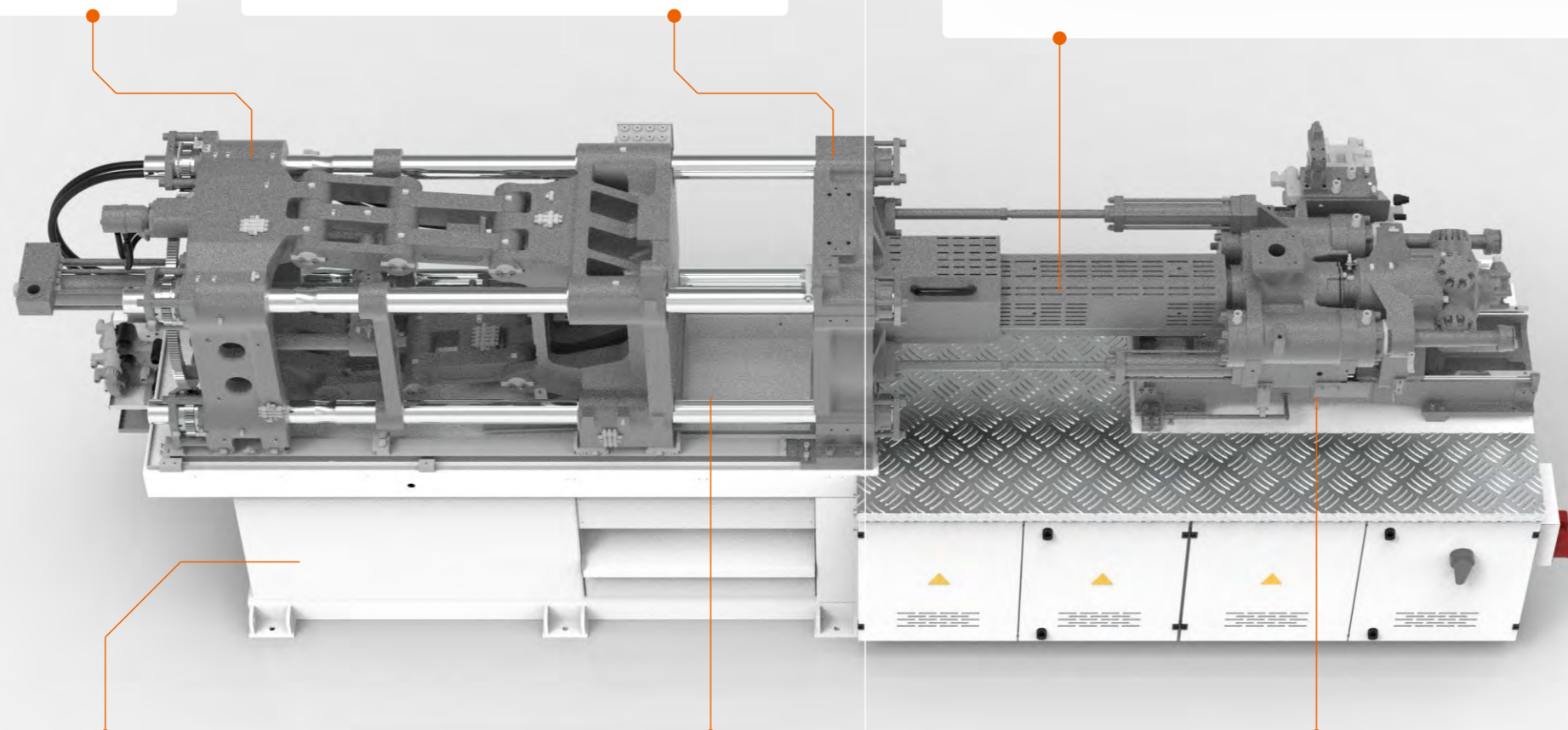

High-strength machine base

Improved structural stability, reduced deformation and enhanced torsion resistance from thicker and stronger I-beams that make up the machine base, plus an optimised design created through high-end computer stress simulations of various loading conditions.

Wide applicability

Highly precise control over speed, pressure and temperature leads to easy processing of a wide range of resins, from PP, ABS to PC, PET, PMMA, PA and more exotic engineering plastics, where the Mk6 PRO shows its professional advantage.

High precision linear guide rails

Silky-smooth - low friction
Reliable - longer usage life
Stable - higher positional accuracy for higher yields
Fast - low friction enables higher speeds and better control
Precision - better control and accuracy leads to higher precision

Redefining high performance

Fastest cycle time for 100% satisfaction

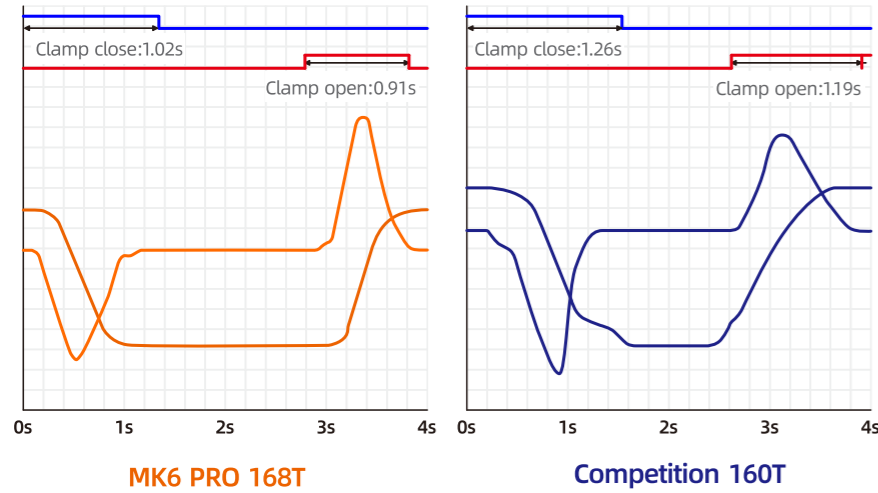

Model	MK6 PRO 168T	Competition 160T
Clamp close(s)	1.02	1.26
Clamp open(s)	0.91	1.19
Cycle time(s)	1.93	2.45
Opening stroke(mm)	300	300

21%
faster dry cycle
than competition

Shorter cycle time brings immediate financial return.

Achieving 100% satisfaction with electric plasticising (optional)

Servo electric plasticising is more energy-efficient, with total efficiency of 90% compared to the traditional hydraulic motor.



Servo electric plasticizing meets the higher production demands of the various industries by utilizing synchronous plasticizing & mold motion.

Equipped with servo electric plasticising for quieter operation

Closed-loop pressure control for 100% satisfaction

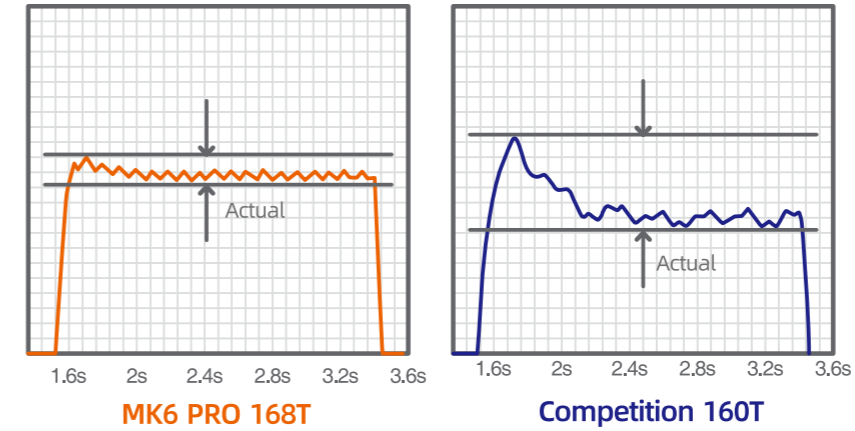

Precision pressure control is critical for good part quality and high yields, especially for demanding applications with strict dimensional stability and surface finish requirements (such as optical parts). Smooth pressure transitions also reduce mechanical shocks and prolong machine usage life.

Closed-loop precision pressure control within $\pm 0.5\%$

A new industry benchmark for low-pressure mould protection

High precision linear potentiometers are used for the clamping, injection and ejector axes which, when combined with high-optimised algorithms, enables superior low-pressure mould protection-effective even with obstacles thinner than 0.1mm (or the thickness of a sheet of paper)

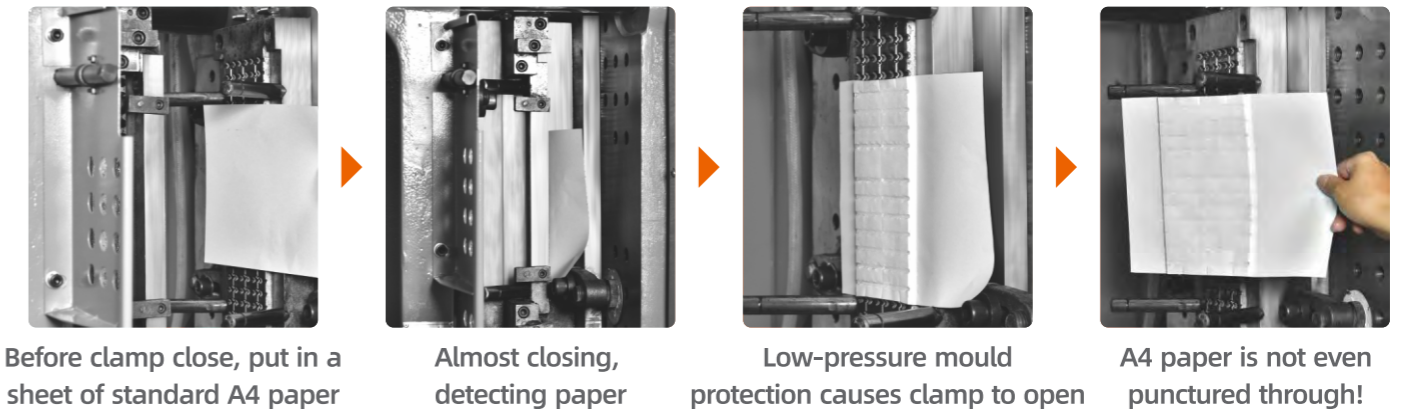

iChen Cloud online data platform for 100% satisfaction

Online monitoring and control at your fingertips. Effectively prevents errors and reduces idle time. Improves utility and delivery accuracy.



iChen Cloud platform

IOT + APS + MES

- Remote monitoring
- Process control
- Production monitoring
- Mould management
- Maintenance
- Analytics
- Automatic scheduling
- Part management
- Quality control

* iPad visualization interface

The iChen Cloud is an optional independent service offering. Contact Chen Hsong personnel for more details.

Injection speed for 100% satisfaction

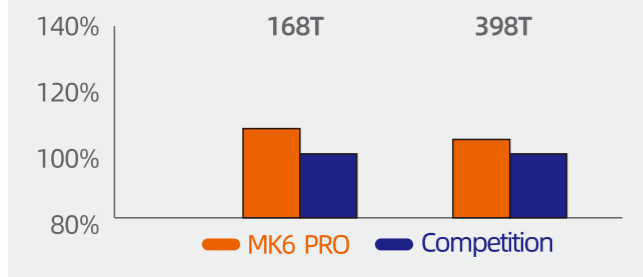

5.5% higher injection speed
Higher injection speed enables more stable production of thin-walled parts with higher yields

Shot weight for 100% satisfaction

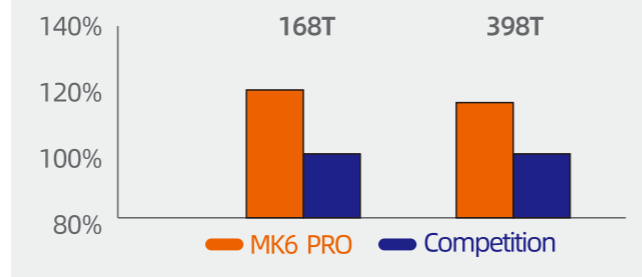

18% larger shot weight
Produce a wider range of parts on the same machine, especially thick-walled ones

Closed-loop high-precision injection for 100% satisfaction

Part Specifications

- Large thin flat testing plate
- Shot-weight: 122g
- Cavities: 1
- Resin: PE
- Cycle time: 16.5s

Part weight distribution

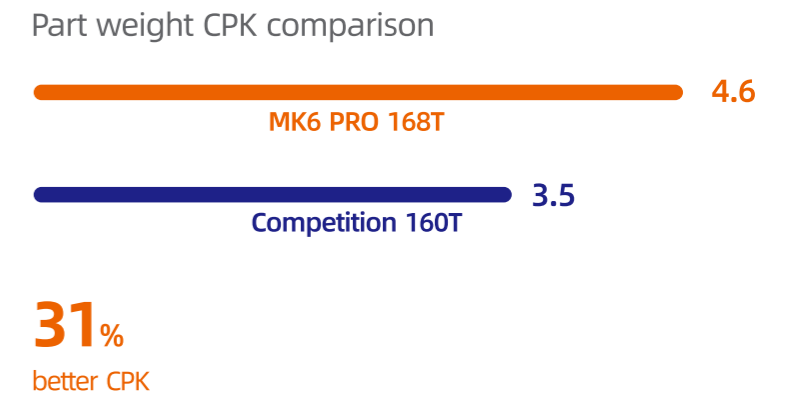
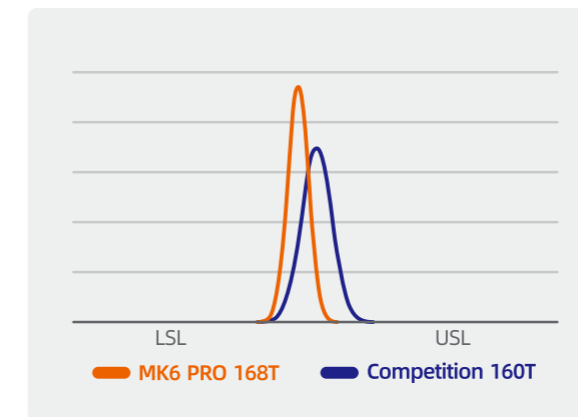

CPK (Process Capability Index) - Higher is better, indicating higher stability and quality. Closed-loop injection can achieve high precision of $\pm 0.15\%$

Opening stroke for 100% satisfaction

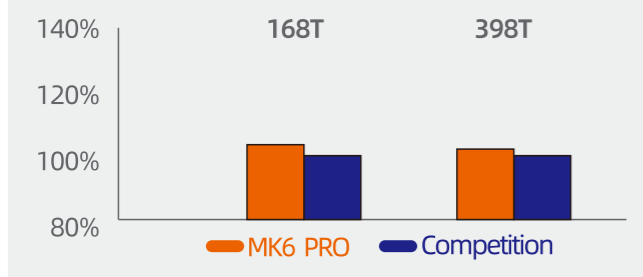

4% longer opening stroke
Longer opening stroke to produce deeper-cavity parts

Power pack for 100% satisfaction

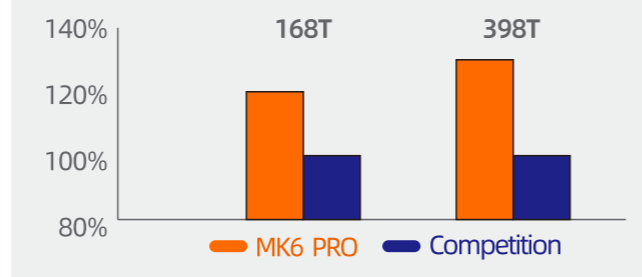
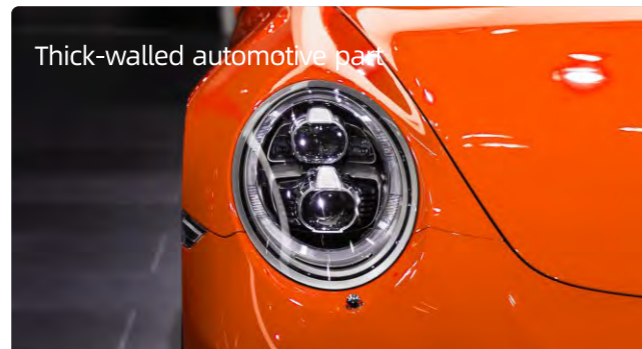

26% larger power pack
Large power pack allows for much longer holding time, ideal for thick-walled parts made with tough engineering plastics

Clamp open position distribution

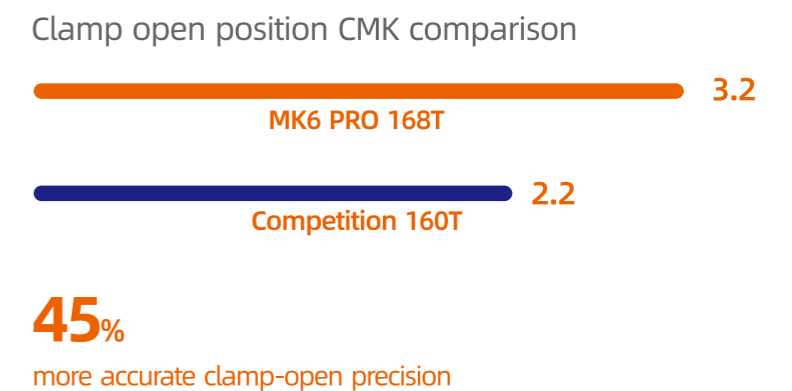
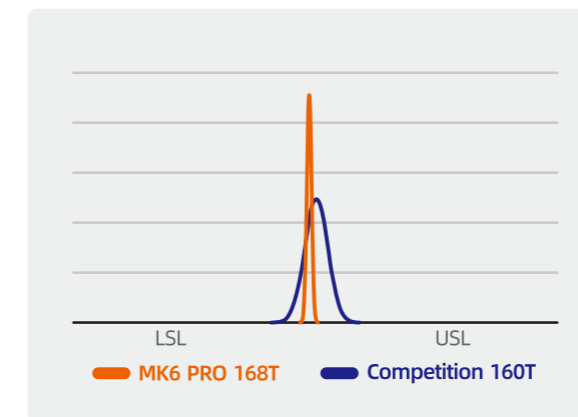

Highly accurate clamp-open position simplifies robot take-out, allowing it to run faster for even shorter cycle time.

In pursuit of 100% complete satisfaction

Rock-solid stability for 100% satisfaction



Only the best machining equipment (e.g. Japanese FMS's and CNC's) are good enough to produce core components for the MK6 PRO, which all but guarantees reliability and stability for long years of operation.

Superior yields for 100% satisfaction



Through precision control of injection speed and pressure, the MK6 PRO is ideal for producing parts with demanding tolerances.

Higher productivity for 100% satisfaction



Productivity is the ultimate goal of the MK6 PRO, which leverages field experiences gained from wild popularity (98%+ repeat order rate) and seeks to exceed them in all aspects.

Standard Features

Clamping Unit

- 1 Automatic toggle lubrication
- 2 Automatic mould thickness and clamping force adjustment
- 3 High-tensile chrome-plated tie-bars
- 4 Safety door with electrical and hydraulic safety interlock protection
- 5 Hydraulic core pulls
- 6 EUROMAP ejector
- 7 Differential boost for high-speed clamping

Injection Unit

- 1 Nitrided screw and Barrel
- 2 Automatic PID temperature control (including nozzle)
- 3 Digital back pressure control
- 4 Nozzle guard
- 5 Cold start prevention
- 6 Screw RPM display
- 7 Broken thermocouple detection alarm
- 8 Ceramic heater
- 9 Barrel safety cover
- 10 Blocked nozzle and overflow detection

Hydraulics

- 1 Low-noise internal gear pump
- 2 High efficiency oil cooler
- 3 Detachable oil tank
- 4 Suction and return line filter
- 5 Hydraulic safety interlock
- 6 Oil temperature control

Controller

- 1 12" touch-screen panel (88-468T) / 15" touch-screen panel (568-668T)

Optional Features

Clamping Unit

- 1 Additional core pulls
- 2 EUROMAP 12 or EUROMAP 67 robot interface with connectors
- 3 T-slots
- 4 SPI mould platen
- 5 Multi-function air blow device
- 6 Mould hanger
- 7 Ejection-on-fly/ core-pull-on-fly
- 8 Large ejector stroke
- 9 Larger max. mould thickness
- 10 Insulation board for mould

Injection Unit

- 1 Barrel thermal insulation cover
- 2 Reduced/ enlarged injection unit
- 3 Cooling ring with temperature control
- 4 Bimetallic barrel
- 5 Stainless-steel hopper
- 6 Extended nozzle
- 7 Shut-off nozzle
- 8 Chrome plated nozzle
- 9 Bimetallic screw
- 10 Cooling Fans on barrel
- 11 eDrive (electric plasticising)
- 12 Infrared barrel heating system
- 13 Mixing screw head
- 14 Rigid PVC specialised injection units
- 15 Movable hopper

Controller

- 1 B&R controller
- 2 Beckhoff controller
- 3 Hot runner temperature control
- 4 Feed-throat temperature control
- 5 sequential valve gate control
- 6 Mega Cloud IOT router

Hydraulics

- 1 Oil level alarm
- 2 Unscrewing device
- 3 3R by-pass filter
- 4 External return line filter
- 5 External suction filter
- 6 Larger screw motor
- 7 Larger oil cooler
- 8 Enlarge power pack
- 9 Hydraulic oil preheat
- 10 High stability hydraulic control
- 11 Injection closed-loop control
- 12 Proportional valve for clamping

MK6 PRO Specifications

Injection Unit	UNITS	JM88-MK6 PRO			JM128-MK6 PRO			JM168-MK6 PRO			JM208-MK6 PRO			JM258-MK6 PRO			JM328-MK6 PRO			JM398-MK6 PRO			JM468-MK6 PRO			JM568-MK6 PRO			JM668-MK6 PRO		
Screw Diameter	mm	31	36	41	36	41	46	41	46	52	46	52	60	46	52	60	60	67	75	67	75	83	75	83	90	75	83	90	83	90	98
Screw L/D	L/D	24.4	21.0	18.4	23.9	21.0	18.7	23.6	21.0	18.6	23.7	21.0	18.2	23.7	21.0	18.2	23.5	21.0	18.8	23.5	21.0	19.0	23.2	21.0	19.4	23.2	21.0	19.4	23.9	22.0	20.2
Screw Stroke	mm	180	180	180	205	205	205	230	230	230	260	260	260	260	260	260	335	335	335	375	375	375	415	415	415	415	415	415	425	425	425
Calculated Injection Capacity	cm ³	136	183	238	209	271	341	304	382	488	432	552	735	432	552	735	947	1181	1480	1322	1657	2029	1833	2245	2640	1833	2245	2640	2300	2704	3206
Practical Injection Shot Weight (PS)	g	124	167	216	190	246	310	276	348	444	393	502	669	393	502	669	862	1075	1347	1203	1508	1846	1668	2043	2403	1668	2043	2403	2093	2460	2917
	oz	4.4	5.9	7.6	6.7	8.7	10.9	9.7	12.3	15.7	13.9	17.7	23.6	13.9	17.7	23.6	30.4	37.9	47.5	42.4	53.2	65.1	58.9	72.1	84.7	58.9	72.1	84.7	73.7	86.6	102.7
Injection Pressure (Max.)	kgf/cm ²	2549	1890	1457	2451	1890	1501	2368	1881	1472	2419	1893	1422	2419	1893	1422	2355	1889	1507	2333	1862	1520	2253	1840	1564	2253	1840	1564	2163	1840	1552
Injection Rate	cm ³ /s	80	108	140	104	135	170	138	174	222	169	216	287	169	216	287	302	376	472	351	440	539	442	541	636	442	541	636	540	635	753
Screw Speed	rpm		245			245			224			200			200			200			190			180			180			170	
Nozzle Contact Force	t		4.2			4.2			6.2			6.2			6.2			9.1			11.1			11.1			12.0			12.0	
Nozzle Stroke	mm		275			290			330			380			380			440			470			540			420			450	

Clamping Unit

Clamping Force (Max.)	t		88			128			168			208			258			328			398			468			568			668	
Opening Stroke	mm		340			380			450			510			560			660			720			820			870			920	
Space Between Tie Bar (HxV)	mm		360x360			410x410			470x470			530x530			580x580			680x680			730x730			830x830			860x860			920x920	
Mould Thickness (Min.)	mm		125			150			170			180			190			225			250			300			350			380	
Mould Thickness (Max.)	mm		380			450			520			550			580			680			730			850			880			920	
Max. Daylight Between Platens	mm		720			830			970			1060			1140			1340			1450			1670			1750			1840	
Ejector Force (Max.)	t		3.4			4.2			4.2			6.7			8.5			11.1			11.1			16.6			16.6			18.2	
Ejector Stroke	mm		120			120			140			150			150			180			215			220			250			265	
Centre Bore			100			100			125			125			125			125			160			160			160			200	

Power Pack

System Pressure	kgf		175			175			175			175			175			175			175			175			175			175	
Pump Power	kW		19			22			26			31			31			58			63			73			73			95	
Barrel Heating	kW		8			10.3			12.9			16.6			16.6			26			31.1			35.5			35.5			35.5	
Temperature Control Zones			3+1			3+1			3+1			3+1			3+1			4+1			5+1			5+1			5+1			5+1	

Others

Machine Dimensions (LxWxH)	m		4.48x1.17x1.88			4.95x1.25x1.94			5.48x1.28x2.02			6.10x1.48x2.15			6.30x1.56x2.24			7.45x1.73x2.21			8.02x1.94x2.19			8.78x2.04x2.26			9.29x1.94x2.33			9.86x2.02x2.24	
Oil Tank Capacity	L		170			220			265			350			350			620			810			920			920			950	
Machine Weight	t		3.3			4.0			4.9			6.8			7.8			13.2			16.7			19.8			21.0			23.0	

Mounting Holes

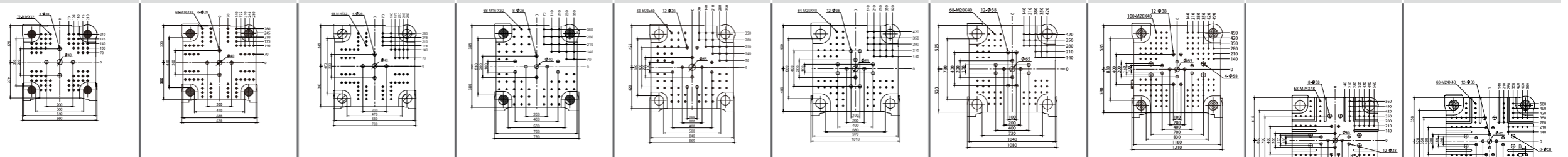

T slots with mounting holes(Optional)

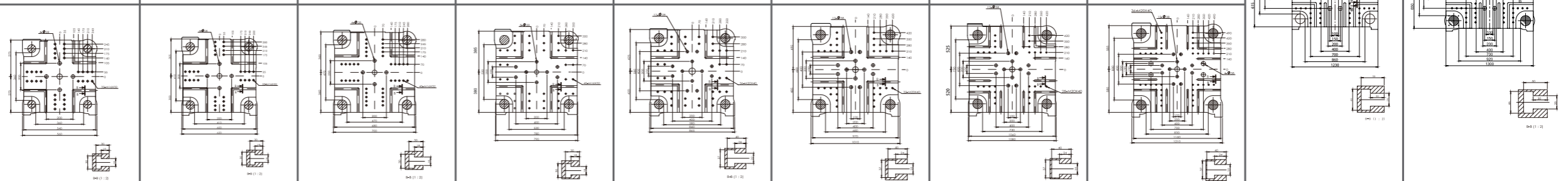

The company keeps upgrading the products and reserves the right to change the product specifications and parameters without prior notice. The final interpretation to the above specifications and parameters belongs to the company.